



Meeting Date:	20 April 2022
Report Type:	Public – for approval
Report Subject:	Lakewood Annual Pan
Agenda Item No:	5(b)
Contact:	Chairman

BACKGROUND:

The Friends of Lakewood have now prepared their Management Plan for 2022/23 (attached) and request parish council approval to it.

The following should be noted:

- The draft Plan was sent to BCP for Countryside officer comments and these have now been incorporated into the Plan.
- The Friends have raised the funds required to implement their plan (materials £1295)
- A bonfire will be lit on 5th November
- The Tree Officer at BCP has been fully consulted by the Friends

RECOMMENDATION

1. To congratulate the Friends on their ambitious plan, and for raising the necessary funds to implement it.
2. To approve the draft plan subject to:
 - A minimum of 1 week's advance notice being given to HWPC of each task day.
 - Fire officer approval being obtained before any bonfire is lit on the site.

PHASE I
STAGE 2

PLAN-24-2-22

LEAVE FOR
DREDGER

REEDS

Nicospan

BARRIER

D

GRASS

NICOSPAN

BARRIER

REEDS

C

ENTHANCE EXISTING
GRAVEL BED

F

INSTALL
MONK

LOCK
GRATE

E

BARRIER

C

REED
BED

WATERPROOF BARRIES

SILT TRAPS

A
FINISH
SLIP
WAY

B

BARRIER

REED
BED

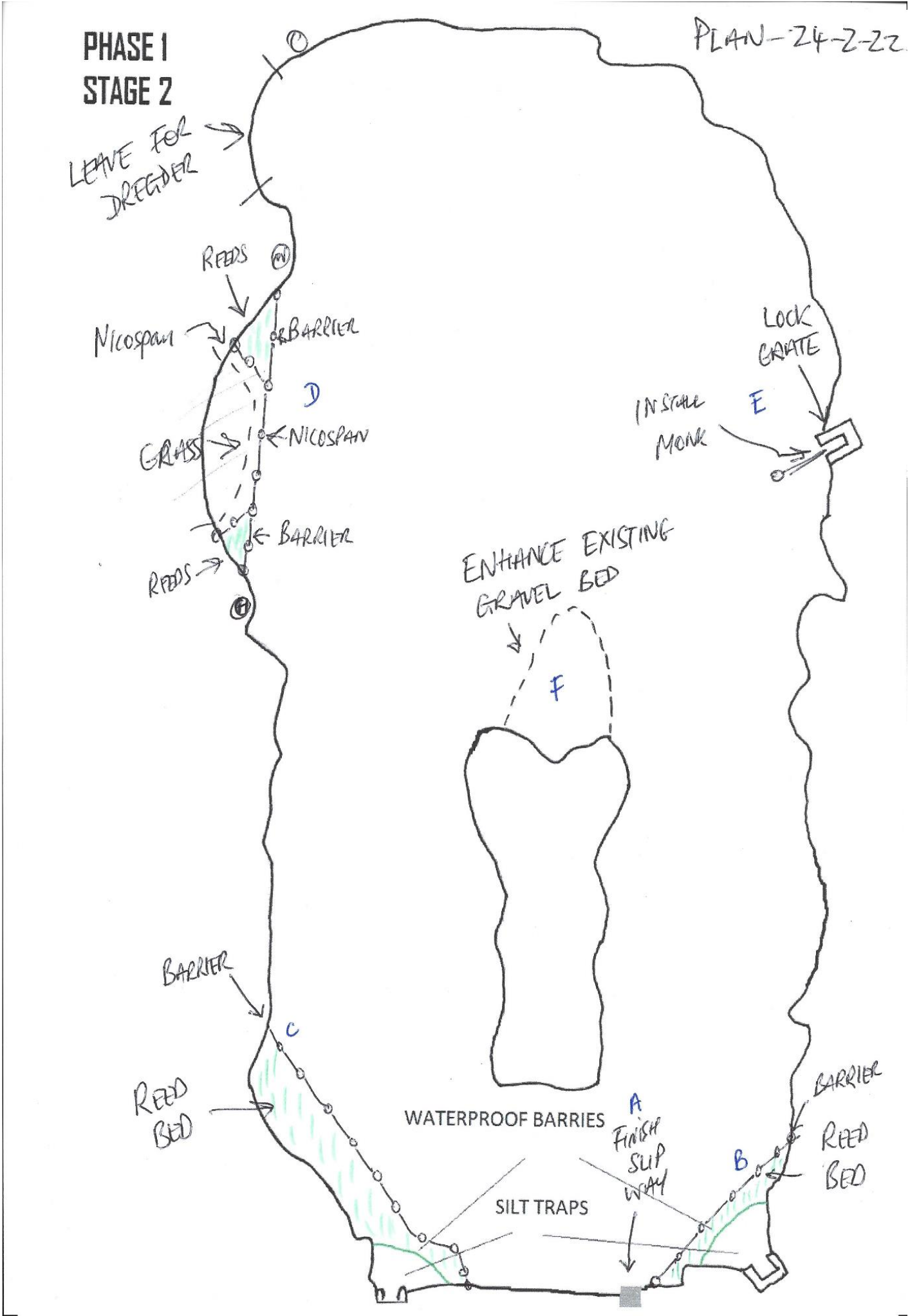



Management Plan for Lakewood from March 2022 to March 2023.

1: Restart Free Fishing Days for children by our qualified coaches from March 2022 to October using the Get Fishing Awards, which teaches children to fish on their own. Dates to be announced one week before each monthly event to general public and Parish council.

Future possible dates for free fishing are : 23/4, 14/5, 11/6, 16/7, 27/8, 17/9, 15/10, 05/11, 10/12.

2: Vegetation proposal – Our Bee Bombs are a native wildflower mix will be sowed in March 2022. Our main activity will be the planting of and care for saplings provided by The Woodland Trust. The trees are scheduled for delivery around the second week in March. There are two packs of 30 saplings each. A “hedge pack” and a “copse” pack. In total, the packs contain around 10 native species.

We have prepared ground to extend the hedge at the Eastern end of the site by around 10m. The “copse” pack will be used to extend the existing planted areas and to “make good” a couple of gaps left by previous fellings.

The saplings are very small and will require watering and protection from competition by other plants, particularly, Bracken, Brambles, Nettles and Thistles.

We will continue to observe the TPO and will seek consent for any desired tree work.

We will also seek to care for areas of recently planted native bulbs, particularly, 300 Bluebells along the Braemar Drive side of the lake. This will entail some minor cutting of Brambles, ground cover Ivy, plus Rhododendron re-growth and seedlings. All further advice for future tree planting will be sought from Jamie Palmer of BCP.

3 : Main Task Day events for the coming year , see details on the Map of the lake, Listed in order of priority.

A : Concrete Ramp extension (March 2022)

B : Installation of Reed Barrier- Brick inlet

C : Installation of Reed Barrier – Plastic pipe inlet

D : Nicospan in front of Old Bench

E : Enhance existing gravel bed – top of the island

F : Install Monk – (Aug/ Sept)

G : New Fishing Rods

PRICE FOR MATIRAILS

A : Concrete Ramp Extension = £ 369.84

From Travis Perkins Somerford with Steve the managers discount .

Ballast bulk bag 2 ton £80.00

Extra rapid cement 16 bags £159.20

Shuttering board 18mm 2440x1220 x3 £69.00

Free use of cement mixer from New Milton Hire

Vat total £61.64

Total £369.84

B : Installation of Reed Barrier (Brick inlet)

Length of barrier 12 meters.

Peeled and pointed round stake 1650mm x 75-100mm x17 = £90.60. from Mole sway.

Kestrel Galvanised chain link fencing - 900mm x 50mm x 12.5 meters = £112.32 . from Mole sway.

Small wire mesh 900mm x 6m x 2 = £ 29.90 from In-Excess.

Tie wraps 76mm x 380mm x25 x2 = £3.20

Total = £236.02

C : Installation of Reed barrier (Plastic pipe inlet)

Length of barrier 12.5 meters.

Peeled and pointed round stakes x 18 = £95.91

Kestrel Galvanised chain fence x 1 = £112.32

Small wire mesh x 2 = £29.90

Tie wraps x 2 = £ 3.20

Total = £241.33.

D : Nicospan in front of old bench

length 12.5 meters .

Nicospan (we still have enough left over) = £ FREE

Peeled and pointed round stakes x 18 = £95.91

Total = £95.91

E : Enhance existing gravel bed in front of the island.

I have clean shingle when ever I want it, permission will be sought from BCP , before we add the shingle. = £ FREE

F : Install Monk at outlet .

We have a list of all the stuff we need for this but we will get prices nearer the time we intend to install the monk , around late Aug/Sept . we have installed a lock on the grid/gate(the spare key is with David at 8, Braemar Drive) and inserted a elvers rope (baby eels) so they can get into the lake easier. Permission for the installation of the Monk will be sought from Simon Hills from Coastal of BCP.

G : New Fishing Rods,

4x feeder rods and reels , 1 x float rod and reel , from
Christchurch Angling Centre = £352.00

Grand Total for works = £ 1295.10

All work done for free

Notes on Reed barriers : The idea of the reed barriers is to prevent said reeds from spreading all over the lake , the reeds in question with be Reedmace, Norfolk reed, Hornwort and Yellow flag Iris will be predominant as guided by Paul Newman of the EA.

Other Events : 5th Nov : We will hold a bonfire night to burn on site branches etc , the Fire Brigade will be informed of fire start and fire out. This will not be a public event , only committee members.

Later in the year we hope to re-stock our fish, as we believe that we lost a lot of fish in the flood of July 2021, plus we have defiantly lost fish to the cormorant that visits the lake

on a regular basis. All new fish we come from a stockist, recommended by the EA.

Plan View

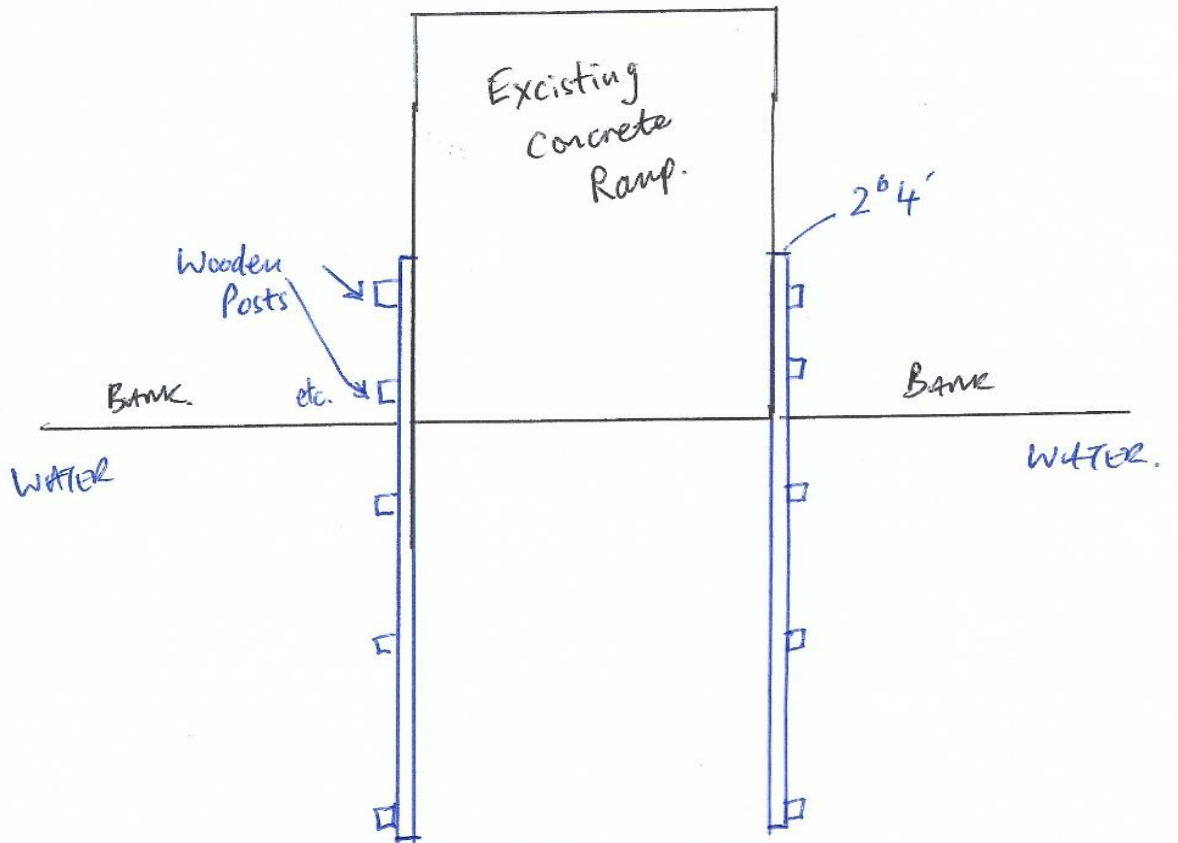

THIS WAS DONE 06/03/2022

Plan View

"Option 2"

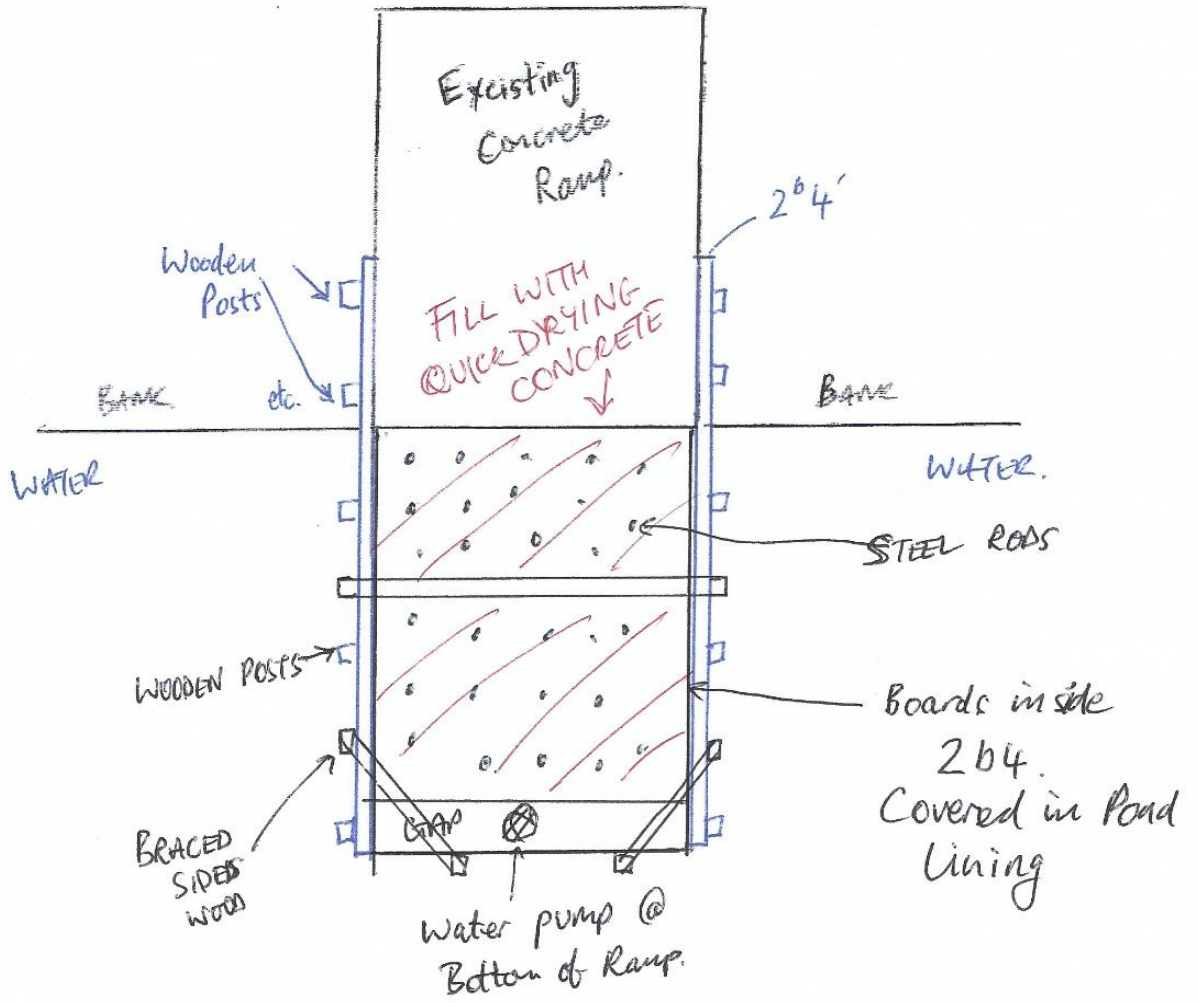

MONK NEW OUTLET

- BENEFITS :
- NO BLOCKING
- NO FISH LOST
- CAN NOT SABOTAGE

Inspection cover

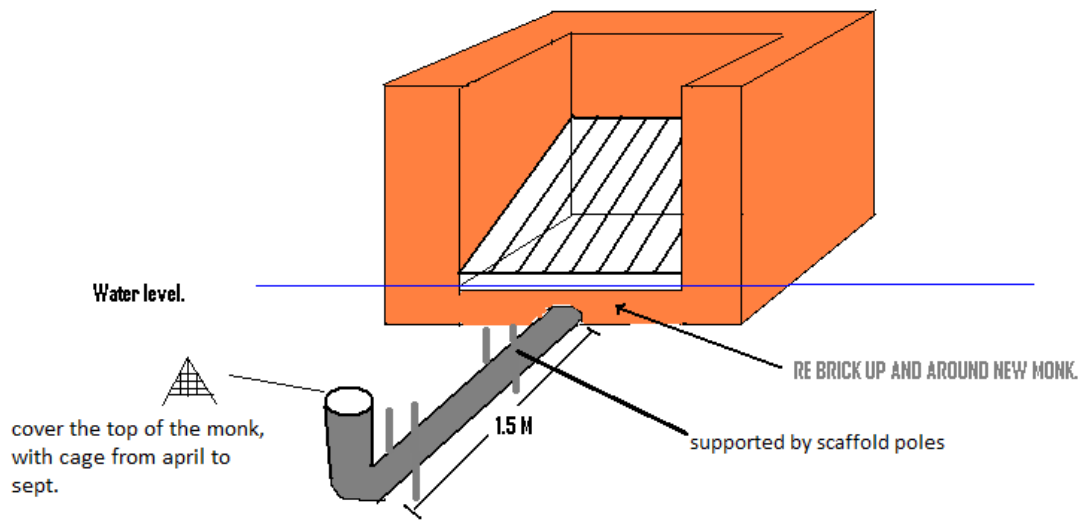

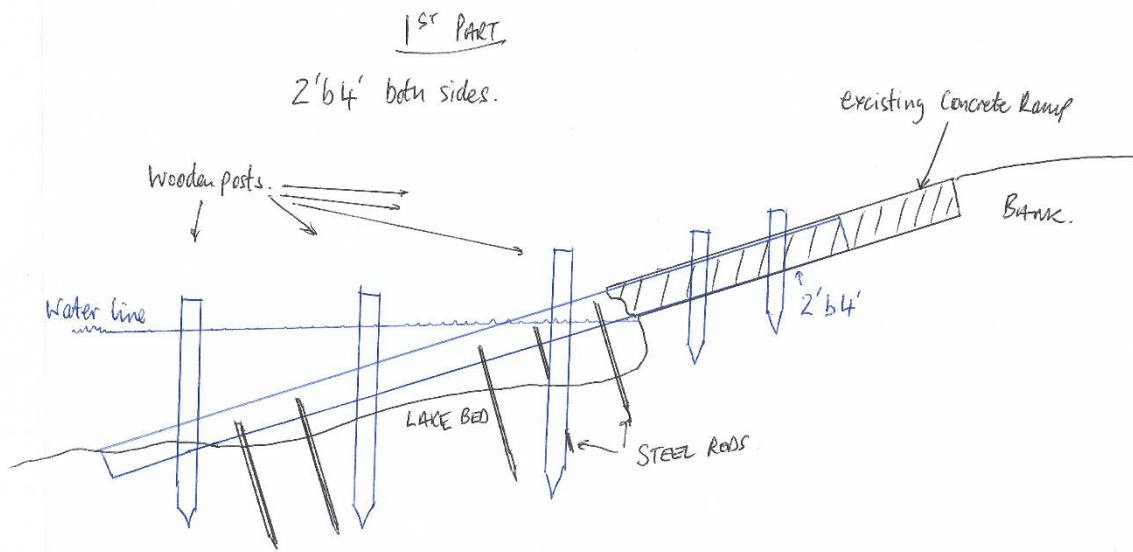

PLAN-24-2-22

CROSS SECTION OF REED BARRIER..

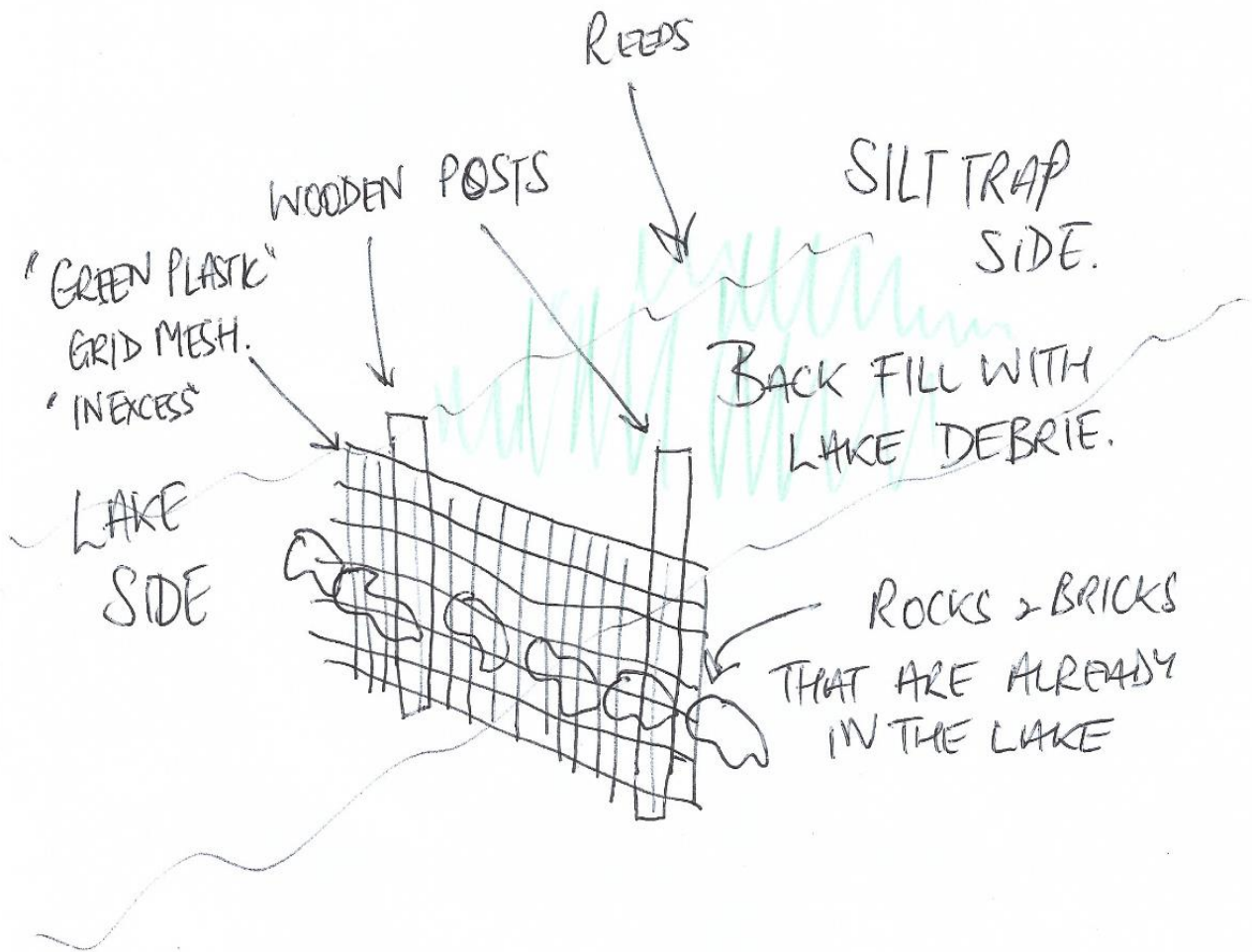

Existing Outlet Problems
Always blocking
Constantly losing Fish
Easily Sabotaged

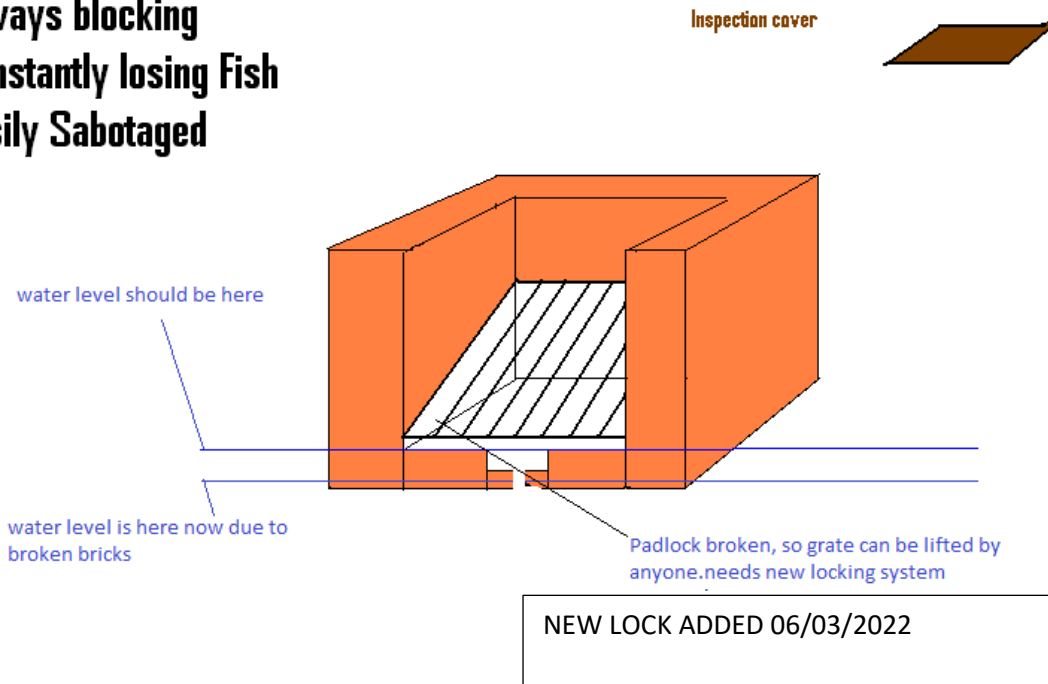

Management Plan

